

PROJECT FIRM ORDER # TYPE QTY







AL Driver 800 C2™ is a Class 2, multi-protocol, 800W driver for low voltage LED products. DMX, 0-10V and DALI control protocols are all supported and additionally RDM, via the DMX input, can be used for remote configuration alterations.



The ten Constant Voltage PWM outputs can be configured to support a range of emitter types, including: single color/white, dynamic white, Ai Dim, RGB or RGBW/RGBA. Outputs can be logically grouped to allow control of multiple LED products using fewer control channels.

Standard 8-bit or extended 16-bit dimming control is available for both DMX and DALI inputs. Additionally, manual dimming levels and internal chase patterns can be selected from the control panel when the AL Driver 800 C2 is used in isolation.

At a glance

 Power input 100 to 277VAC 50/60Hz	 Outputs 10x 24VDC (PWM dimming)	 Temperature 14° F to 113° F -10° C to 45° C	 Protection Ingress: IP20 (dry location)	 Control inputs DMX/ RDM 0-10V (sink or source) DALI
----------------------------------------------------------------------------------------------------------------------------------	--------------------------------------------------------------------------------------------------------------------------------	--------------------------------------------------------------------------------------------------------------------------------------------	----------------------------------------------------------------------------------------------------------------------------------------	-------------------------------------------------------------------------------------------------------------------------------------------------------------------

Specifications

Power input	100-277VAC, 50/60Hz
Output voltage	24VDC
Output current	4A (96W) maximum per output port
Maximum power consumption	960W
Control input protocols	8 bit or 16 bit DMX+RDM, 0-10V (sink or source), DALI
Internal sensors	Temperature: current, minimum and maximum values available via the on-board display
Material / finish	Steel / black powder coat
Ambient temperature range	14° F to 113° F (-10° C to 45° C)
Ingress protection	IP20, dry location
Fixture connectors	6-pin terminal blocks for PWM outputs, 3-pin terminals for DMX, 2-pin terminals for 0-10V & DALI
Warranty	5 years, limited
Weight	12.1 lbs (5.5 kg)
Dimensions	See page 3
Certifications	 



Order code
ALD824-C2

PROJECT _____ FIRM _____ ORDER # _____ TYPE _____ QTY _____

Control input wiring

DMX In / Out

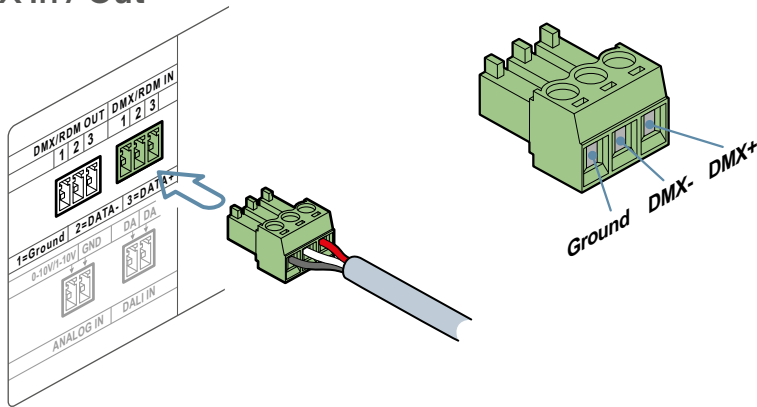

DALI Input

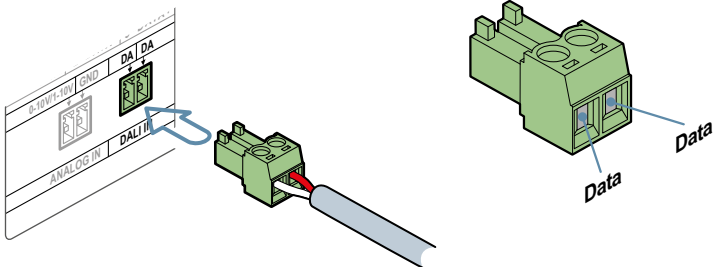

0-10V Input

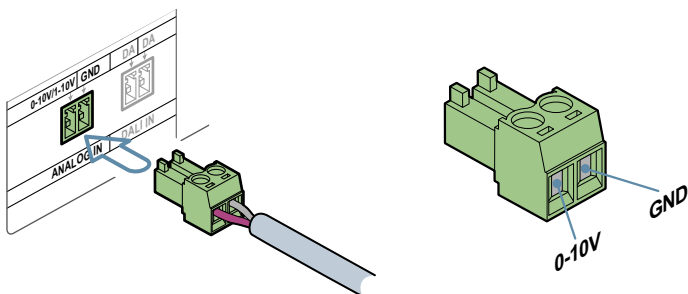

Output port wiring

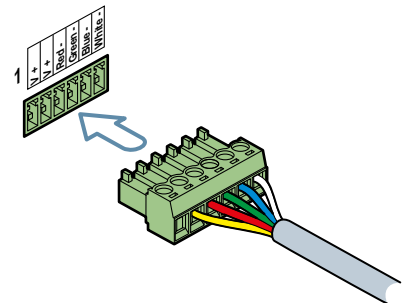

V +	V +	Red -	Green -	Blue -	White -
-----	-----	-------	---------	--------	---------

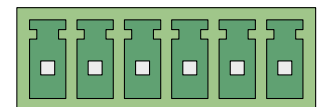

LOAD = RGB	V+	V+	Red	Green	Blue	
LOAD = RGBW	V+	V+	Red	Green	Blue	White
LOAD = AID	V+	V+	W1	W2	W3	W4
LOAD = DW	V+	V+	Warm	Cold	Warm	Cold
LOAD = WHITE	V+	V+	White	White	White	White



PROJECT FIRM ORDER # TYPE QTY

Dimensions

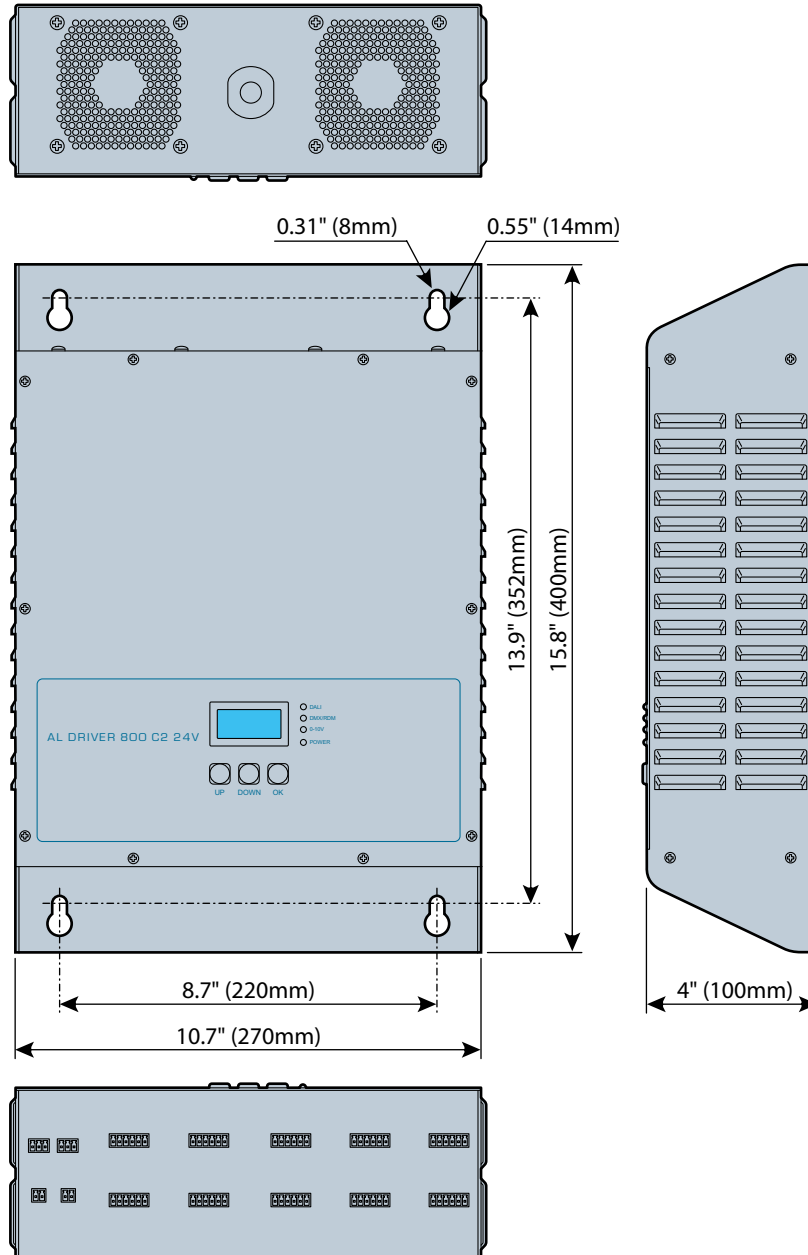

For full installation details, please refer to the **user guide**, available for free download here:

